

Original Operating Instructions
S-VSI 300 (43) OXY
vacuum pump

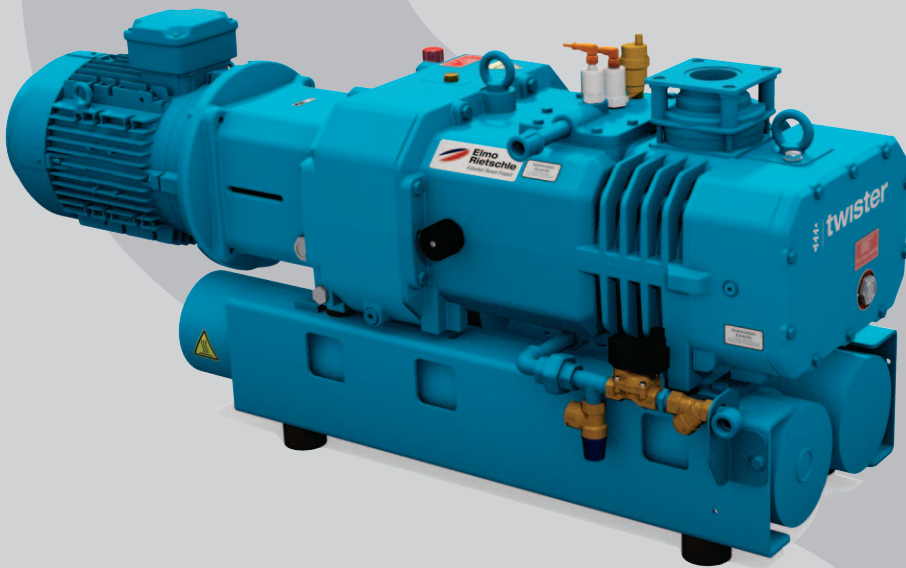

S-Serie
S-Series
Schraube
Screw



Table of contents

1	Foreword	4
1.1	Principles	4
1.2	Target group	4
1.3	Supplier documentation and accompanying documents	4
1.4	Abbreviations	4
1.5	Directives, standards, laws	4
1.6	Symbols and meaning	5
1.7	Technical terms and meaning	5
1.8	Copyright	5
2	Safety	6
2.1	Warning instruction markings	6
2.2	General	6
2.3	Designated use	7
2.4	Unacceptable operating modes	7
2.5	Personal qualifications and training	8
2.6	Safety-conscious work	8
2.7	Safety notes for the operator	8
2.8	Safety instructions for installing, commissioning and maintenance	9
2.9	Guarantee conditions	9
3	Transport, storage and disposal	10
3.1	Transportation	10
	3.1.1 Unpack and check the delivery condition	10
	3.1.2 Lifting and transporting	10
3.2	Storage	11
	3.2.1 Ambient conditions for storage	11
3.3	Disposal	11
4	Set up and operation	12
4.1	Setup	12
	4.1.1 Data plate	14
4.2	Description	14
4.3	Areas of application	15
4.4	Cooling the machine	16
	4.4.1 Continuous flow cooling (Standard version)	16
	4.4.2 Control unit (option)	16
	4.4.3 Circulation cooling (option)	17
5	Installation	18
5.1	Preparing for installation	18
5.2	Installation	19
5.3	Connecting pipes	20
5.4	Connecting the cooling water pipe	21
5.5	Filling with lubricating oil	22
5.6	Connecting the motor	23

6	Commissioning and decommissioning	24
6.1	Commissioning	24
	6.1.1 Checking the rotation direction.	26
	6.1.2 Post-run	26
6.2	Decommissioning/ storing	27
6.3	Re-commissioning	27
7	Maintenance and repair	28
7.1	Ensuring operational safety	29
7.2	Maintenance work	29
	7.2.1 Changing the oil	30
	7.2.2 Air filtering.	32
	7.2.3 Coupling	34
	7.2.4 Cooling	34
7.3	Repair/ Service.	35
7.4	Spare parts.	36
8	Malfunctions: Causes and elimination	37
9	Technical Data	39

Foreword

1 Foreword

1.1 Principles

These operating instructions:

- are a part of the following screw vacuum pumps S-VSI 300 (43) OXY.
- describe how to use them safely and properly in all life phases.
- must be available where the equipment is used.

1.2 Target group

The target group for these instructions is technically trained specialists.

1.3 Supplier documentation and accompanying documents

Document	Contents	No.
Supplier documentation	Operating Instructions	BA 832-43-EN
	Declaration of Conformity	C 0084-EN
	Declaration of harmlessness	7.7025.003.17
Spare parts' list	Spare parts document	E 832/6
Data sheet	Technical data and graphs	D 832/43
Info sheet	Storage guidelines for machines	I 150-EN
Info sheet	Recommended water quality	I 832-EN
Manufacturer's declaration	EU Directive 2011/65/EU (RoHS II)	—



1.4 Abbreviations

Fig.	Figure
S-VSI	Vacuum pump
m ³ /h	Pumping capacity
mbar (abs.)	Final vacuum, operating vacuum

1.5 Directives, standards, laws

See Conformity Declaration

1.6 Symbols and meaning

Symbol	Explanation
▷	Condition, pre-requisite
####	Instructions, action
a), b),...	Instructions in several steps
⇒	Results
 [-> 14]	Cross reference with page number
	Information, note
	Safety symbol Warns of potential risk of injury Obey all the safety instructions with this symbol in order to avoid injury and death.

1.7 Technical terms and meaning

Term	Explanation
Machine	Pump and motor combination ready to be connected
Motor	Pump drive motor
Vacuum pump	Machine to create a vacuum
OXY	Vacuum pumps for handling of gases with raised oxygen-share and other oxidants
Screw	Machine's design or active principle
Pumping capacity	Vacuum pump volume flow related to the condition in the suction connection
Final pressure (abs.)	The maximum vacuum that a pump reaches when the suction opening is closed. Given as absolute pressure.
Permanent vacuum	The vacuum or the suction range at which the pump operates permanently. The permanent vacuum or intake pressure is \geq than the final vacuum and $<$ than the atmospheric pressure.
Noise emission	The noise emitted at a specific loading given as a figure, sound pressure level dB(A) as per EN ISO 3744.





1.8 Copyright

Passing on or copying this document, using and providing information on its contents are prohibited unless expressly permitted. Contraventions will lead to claims for damages.

2 Safety

The manufacturer is not responsible for damage if you do not follow all of this documentation.

2.1 Warning instruction markings

Warning	Danger level	Consequences if not obeyed
 DANGER	immediately imminent danger	Death, severe bodily injury
 WARNING	possible imminent danger	Death, severe bodily injury
 CAUTION	possible hazardous situation	Slight bodily injury
 NOTICE	possible hazardous situation	Material damage

2.2 General

These operating instructions contain basic instructions for installation, commissioning, maintenance and inspection work which must be obeyed to ensure the safe operation of the machine and prevent physical and material damage.

The safety instructions in all sections must be taken into consideration. The operating instructions must be read by the responsible technical personnel/ operator before installing and commissioning/ and must be fully understood. The contents of the operating instructions must always be available on site for the technical personnel/ operator. Instructions fixed directly onto the machine must be obeyed and must always remain legible. This applies for example to:

- Symbols for connections
- Data and motor data plate
- Instruction and warning plates

The operator is responsible for observing local regulations.

2.3 Designated use

The machine must only be operated in such areas as are described in the operating instructions:

- only operate the machine in a technically perfect condition
- do not operate the machine when it is only partially assembled
- the machine must only be operated at an ambient temperature and suction temperature of between 5 and 40°C.
Please contact us for temperatures outside this range.
- the machine may convey, compress or extract the following media:
 - all non-explosive, non-inflammable, non-aggressive and non-poisonous dry gases and gas air mixtures
 - also to feed in extremely damp gases. The water vapour compatibility is very high.
 - suitable for vacuuming of air or other gases with raised oxygen-share (volume-share > 21%) and other oxidants

2.4 Unacceptable operating modes

- extracting, conveying and compressing explosive, inflammable, aggressive or poisonous media, e.g. dust as per ATEX zone 20-22, solvents, water vapour, liquids or solid materials
- using the machine in non-commercial plants if the necessary precautions and protective measures have not been taken in the plant
- installing in environments that are at risk of explosions
- using the machine in areas with ionising radiation
- back pressures on the outlet side:

S-VSI (43) 7.5 kW	< +0.2 bar
S-VSI (43) 5.5 kW	< +30 mbar
- Modifications to the machine and accessories

2.5 Personal qualifications and training

- Ensure that people entrusted with working on the machine have read and understood these operating instructions before starting work, particularly the safety instructions for installation, commissioning, maintenance and inspection work.
- Manage the responsibilities, competence and monitoring of staff
- all work must only be carried out by technical specialists:
 - Installation, commissioning, maintenance and inspection work
 - Working with electricity
- personnel being trained to work on the machine must be supervised by technical specialists only

2.6 Safety-conscious work

The following safety regulations apply in addition to the safety instructions and intended use listed in these instructions:

- Accident prevention regulations, safety and operating regulations
- the standards and laws in force

2.7 Safety notes for the operator

- hot parts of the machine must not be accessible during operation or must be fitted with a guard
- People must not be endangered by the free extraction or discharge of pumped media
- Risks arising from electrical energy must be eliminated.
- The machine must not be in touch with inflammable substances.
Danger of fire by hot surfaces, discharge of pumped media or cooling air

2.8 Safety instructions for installing, commissioning and maintenance

- The operator will ensure that any installation, commissioning and maintenance work is carried out by authorised, qualified specialists who have gained sufficient information by an in-depth study of the operating instructions.
- Only work on the machine when it is idle and cannot be switched on again
- Ensure that you follow the procedure for decommissioning the machine described in the operating instructions.
- Fit or start up safety and protective devices again immediately after finishing work.
- Conversion work or modifications to the machine are only permissible with the manufacturer's consent.
- Only use original parts or parts approved by the manufacturer. The use of other parts may invalidate liability for any consequences arising.
- Keep unauthorised people away from the machine

2.9 Guarantee conditions

The manufacturer's guarantee or warranty will no longer apply in the following cases:

- Improper use
- Not complying with these instructions
- Operation by insufficiently qualified staff
- Using spare parts that have not been approved by **Gardner Denver Schopfheim GmbH**
- Unauthorised modifications to the machine or the accessories supplied by **Gardner Denver Schopfheim GmbH**

3 Transport, storage and disposal

3.1 Transportation

3.1.1 Unpack and check the delivery condition

- a) Unpack the machine on receipt and check for transport damage.
- b) Notify the manufacturer of transport damage immediately.
- c) Dispose of the packaging in accordance with the local regulations in force.

3.1.2 Lifting and transporting



WARNING

Death or limbs crushed as a result of the items being transported falling or tipping over.

- ▷ When transporting with the lifting device remember:
- a) Select the lifting device suitable for the total weight to be transported.
 - b) Ensure that the machine cannot tip and fall.
 - c) Do not stop under a suspended load.
 - d) Put the goods to be conveyed on a horizontal base.

Lifting device/ Transporting with a crane



WARNING

Bodily injury resulting from improper operation

- a) Loads crosswise to the ring level are not permitted.
 - b) Avoid impact stress.
- a) Tighten the eyebolts (Fig. 1/1) firmly.
 - b) The machine must be suspended on the eyebolt using the lifting device for lifting and transporting.

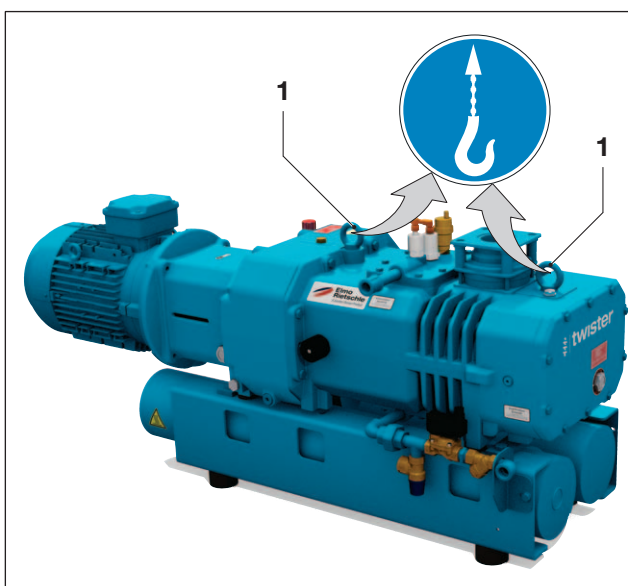

Fig. 1 Lifting and transporting

1 Eyebolt

3.2 Storage

NOTICE

Material damage caused by improper storage.

- ▷ Ensure that the storage area meets the following conditions:
 - a) dust free
 - b) vibration free

3.2.1 Ambient conditions for storage

Ambient conditions	Value
Relative humidity	0% to 80%
Storage temperature	-10°C to +60°C



The machine must be stored in a dry environment with normal air humidity. It should not be stored for more than 6 months.

📄 see Info “Machine storage guidelines”, Page 4

3.3 Disposal

⚠️ WARNING

Danger from inflammable, corrosive or poisonous substances!

Machines that come into contact with hazardous substances must be decontaminated before disposal.

- ▷ When disposing ensure the following:
 - a) Collect oils and grease separately and dispose of in accordance with the local regulations in force.
 - b) Do not mix solvents, cold cleaners and paint residues.
 - c) Remove components and dispose of them in accordance with the local regulations in force.
 - d) Dispose of the machine in accordance with the national and local regulations in force.
 - e) Parts subject to wear and tear (marked as such in the spare parts list) are special waste and must be disposed of in accordance with the national and local waste laws.

4 Set up and operation

4.1 Setup

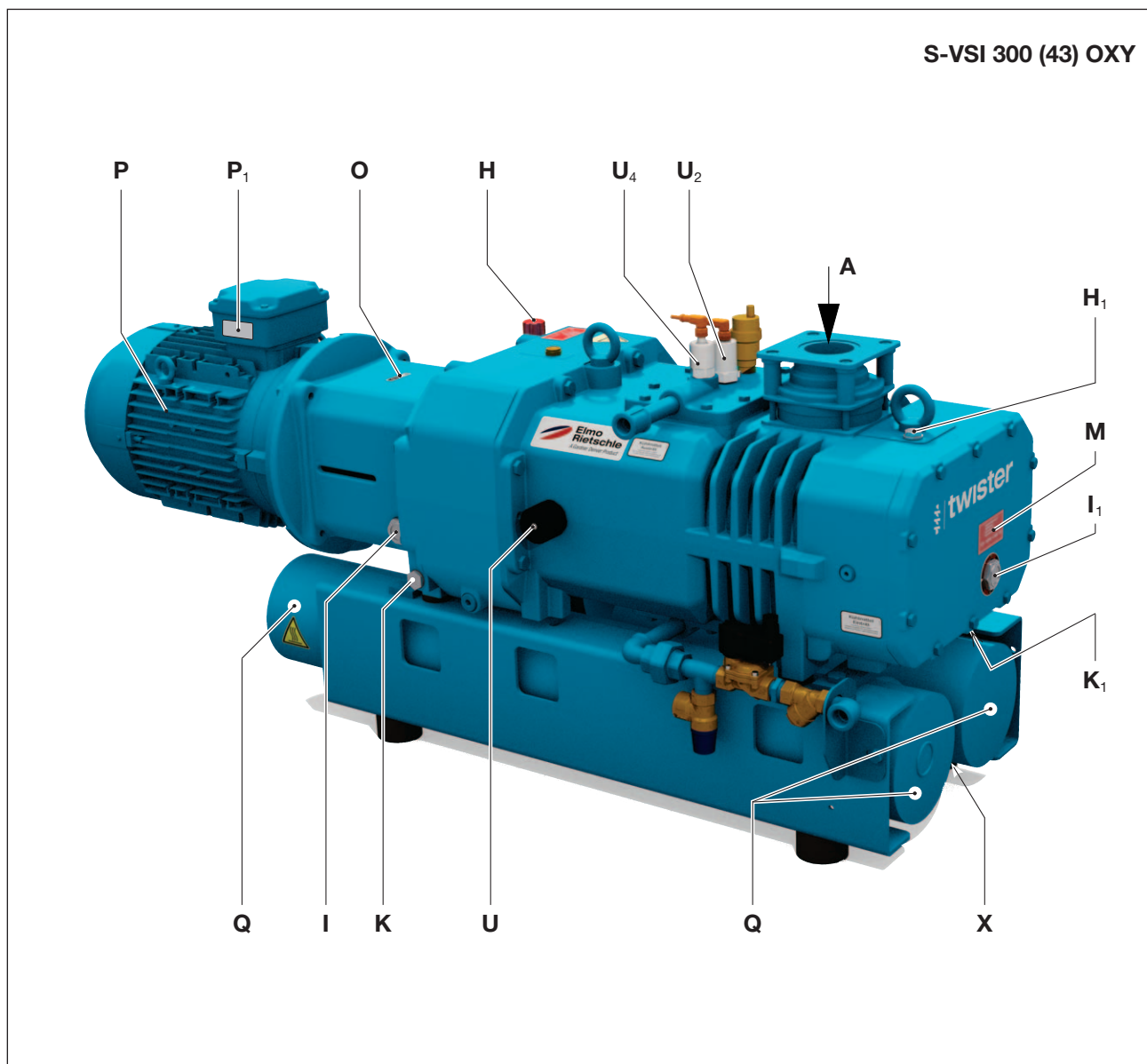

Fig. 2 Vacuum pump S-VSI 300 (43) OXY

- | | | | |
|-------------------------|--------------------------|----------------------|--|
| A | Vacuum connection | P₁ | Motor data plate |
| H, H₁ | Oil filling point | Q | hot surfaces > 70°C |
| I, I₁ | Oil sight glass | U | Gas ballast valve |
| K, K₁ | Oil discharge point | U₂ | Temperature control |
| M | Oil recommendation plate | U₄ | Liquid level monitor |
| O | Rotation direction plate | X | Condensate drain G ¹ / ₂ |
| P | Drive motor | | |

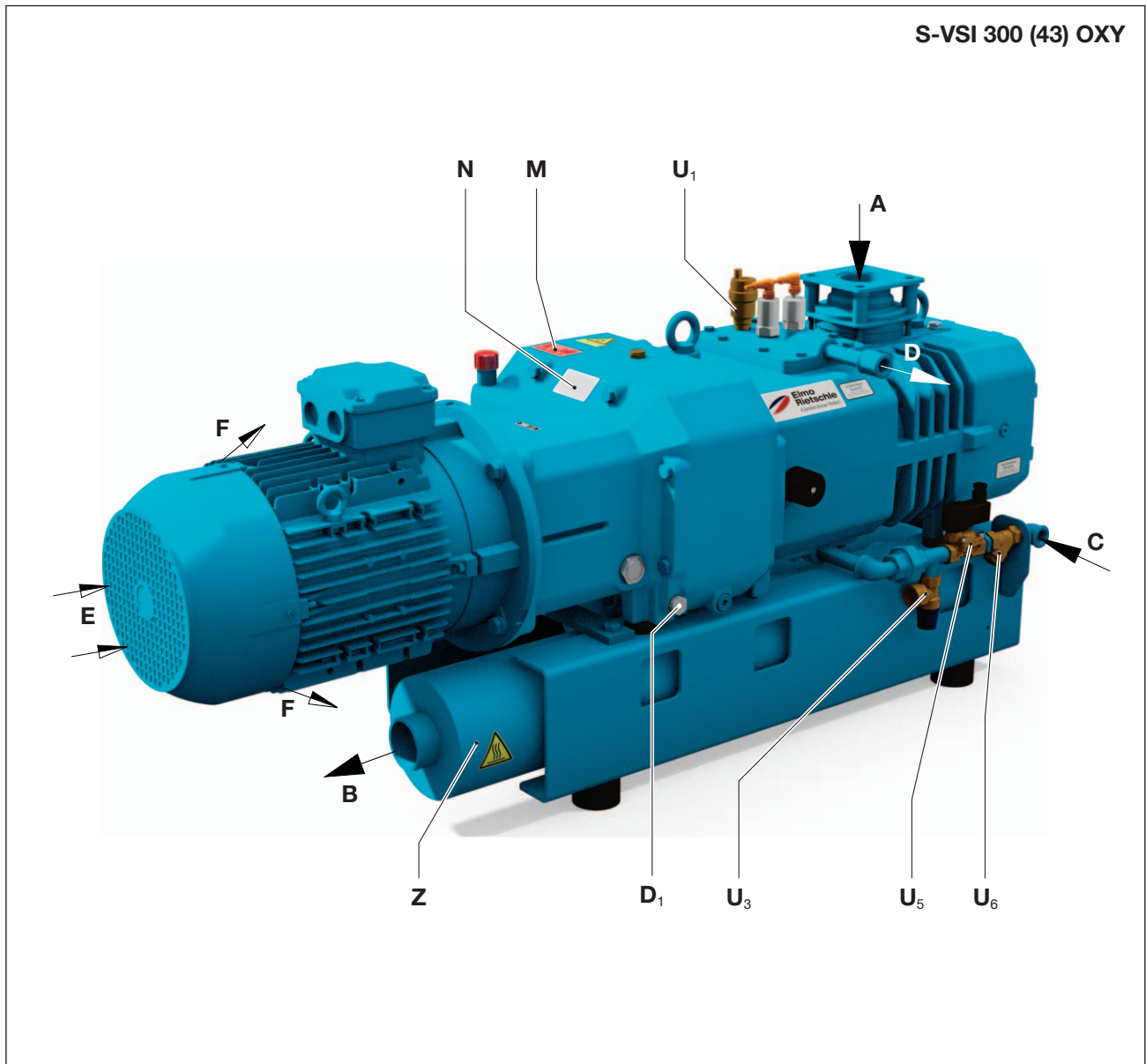

Fig. 3 Vacuum pump S-VSI 300 (43) OXY

A	Vacuum connection	M	Oil recommendation plate
B	Exhaust air outlet	N	Data plate
C	Cooling water inlet G $\frac{1}{2}$	U₁	Vent valve
D	Cooling water outlet G $\frac{1}{2}$	U₃	Safety valve
D₁	Cooling water drain	U₅	Solenoid valve
E	Cooling air inlet	U₆	Dirt trap
F	Cooling air outlet	Z	Outlet silencer

Set up and operation

4.1.1 Data plate

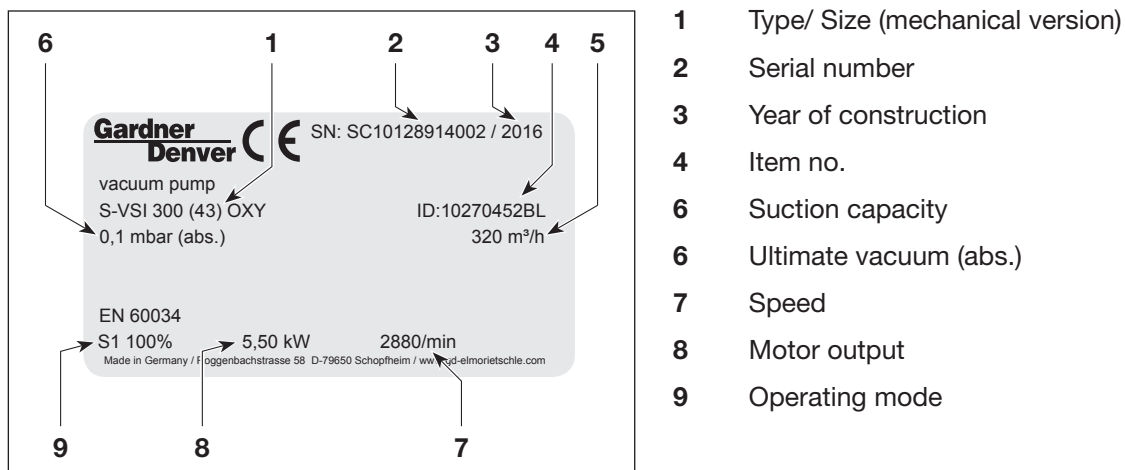

Fig. 4 Data plate

4.2 Description

The S-VSI model range has a connecting thread on the suction side and an exhaust silencer with connecting thread on the pressure side.

The TWISTER S-VSI is a double shaft screw vacuum pump in which two parallel screw rotors roll off against each other without touching and dry. The gas to be fed in is here enclosed in the pump's suction chamber and compressed by the rotary movement of the screw rotors in the direction of the outlet. The gas sucked in is gradually compressed to atmospheric pressure. The counter-rotating screw rotors are synchronised by a gear pair in the gearbox. The synchronous gearbox gear wheels and the bearings are lubricated with oil. These components are in a gearbox that also contains the oil supply. Oil conveying devices always ensure that the bearings and the gear wheels are sufficiently supplied with oil at all permissible speeds.

The gearbox and the compression chamber are separated from each other by special seals. The gearbox is sealed from the outside with shaft seals and O rings, the compressor chamber with piston rings. Between the two there is also another atmospherically ventilated area that can be loaded with sealing gas (special version).

A gas ballast valve fitted as standard (Fig. 2/U) reduces at its operating temperature condensation of water vapour in the inside of the pump.

For better differentiation compared with the standard versions the VSI OXY pumps are varnished in blue colour.

The TWISTER S-VSI is driven by standard flanged three phase motors via a coupling (with an elastomer component).

4.3 Areas of application

The screw pumps VSI OXY are suitable for vacuuming of air or other gases with raised oxygen-share (volume-share > 21%).

They are suitable for the evacuation of closed systems or for a continuous vacuum within the following intake pressure ranges: 0.1 to 1000 mbar (abs.).

They are also particularly suitable for feeding in extremely damp gases. The water vapour compatibility is very high.

The maximum pumping capacity with free suction is 320 m³/h at 50 Hz. Data sheet D 832/43 shows the dependency of the pumping capacity on the intake pressure.



If the unit is switched on more frequently (at regular intervals of > 10 times an hour) or at higher ambient temperatures and intake temperatures, the excess temperature limit of the motor winding and the bearings may be exceeded. Please contact the manufacturer should the unit be used under such conditions.



If it is installed in the open air the unit must be protected from environmental influences, (e.g. by a protective roof).

ACHTUNG

The screw vacuum pump **S-VSI300 (43) OXY** with **5.5 kW** motor may only be operated in continuous operation S1.

When evacuating closed systems the volume to be evacuated must be max. 80l.

Set up and operation

4.4 Cooling the machine

4.4.1 Continuous flow cooling (Standard version)

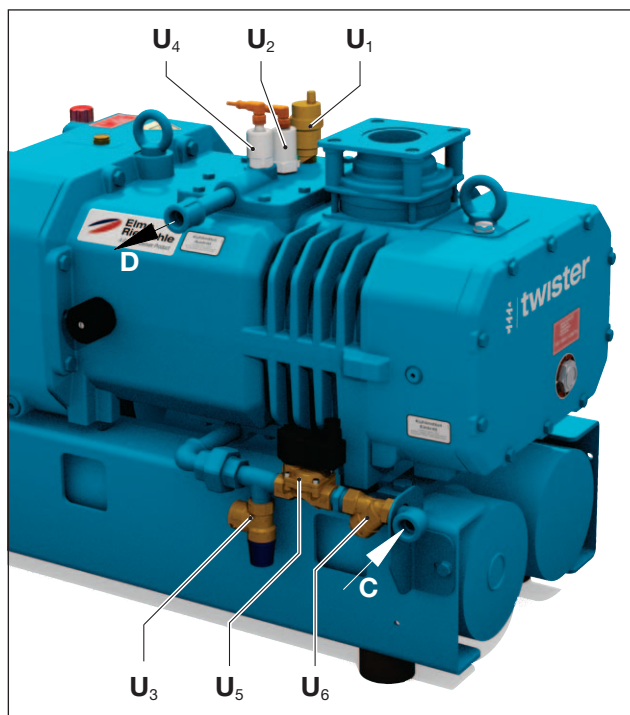

ig. 5 Closed circuit water cooling

- C** Cooling water inlet G $\frac{1}{2}$
- D** Cooling water outlet G $\frac{1}{2}$
- U₁** Vent valve
- U₂** Temperature control
- U₃** Safety valve
- U₄** Liquid level monitor
- U₅** Solenoid valve
- U₆** Dirt trap

4.4.2 Control unit (option)

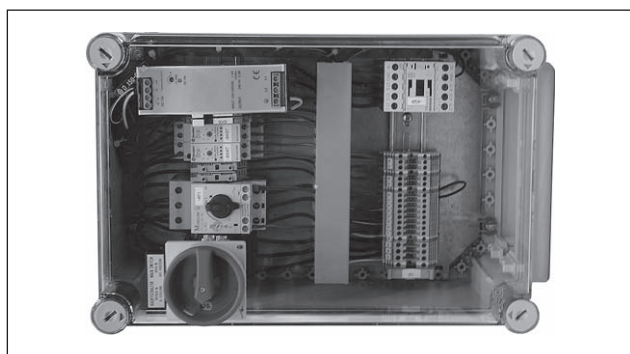

Fig. 6 Control unit (option)

With continuous flow cooling water flows continuously through the cavity in the double walled compressor housing.

For safety reasons the cooling system is fitted with a solenoid valve, temperature control and a safety valve.

A special control unit and a thermostatic water valve are obtainable.

Temperature control

Monitors the temperature of the cooling water.
Factory-provided adjustment: $T_{\max} = 60^{\circ}\text{C}$

Safety valve

Protect from an incorrect operating pressure of the cooling water > 6 bar.

Solenoid valve

Regulate the cooling circuit.
Control voltage: 24V DC

Dirt trap

Protect the armatures and the cooling circuit from impurities in the incoming cooling liquid.

Thermostatic water valve (option)

Fresh water cooling control
Factory-provided adjustment: $T_{\max} = 55^{\circ}\text{C}$

- 📄 The Operating Instructions for the monitoring device are enclosed next to the machine.

Control unit (option)

Analyse the signals of the monitoring devices and control motor as well as solenoid valve.

4.4.3 Circulation cooling (option)

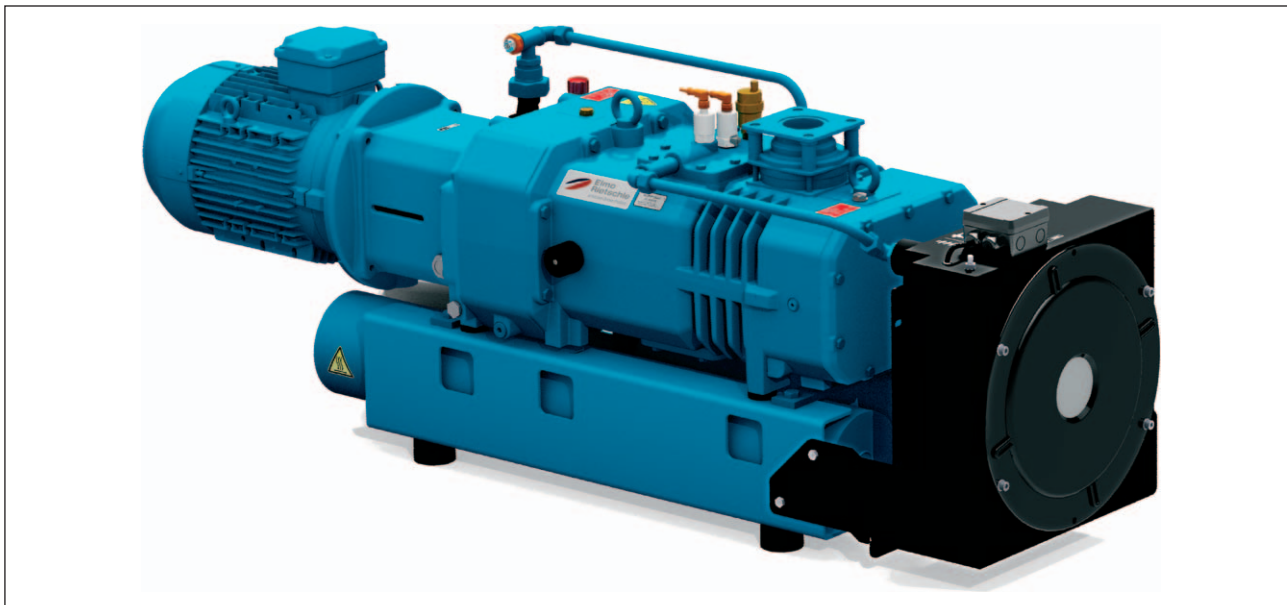

Fig. 7 Closed circuit water cooling (option)

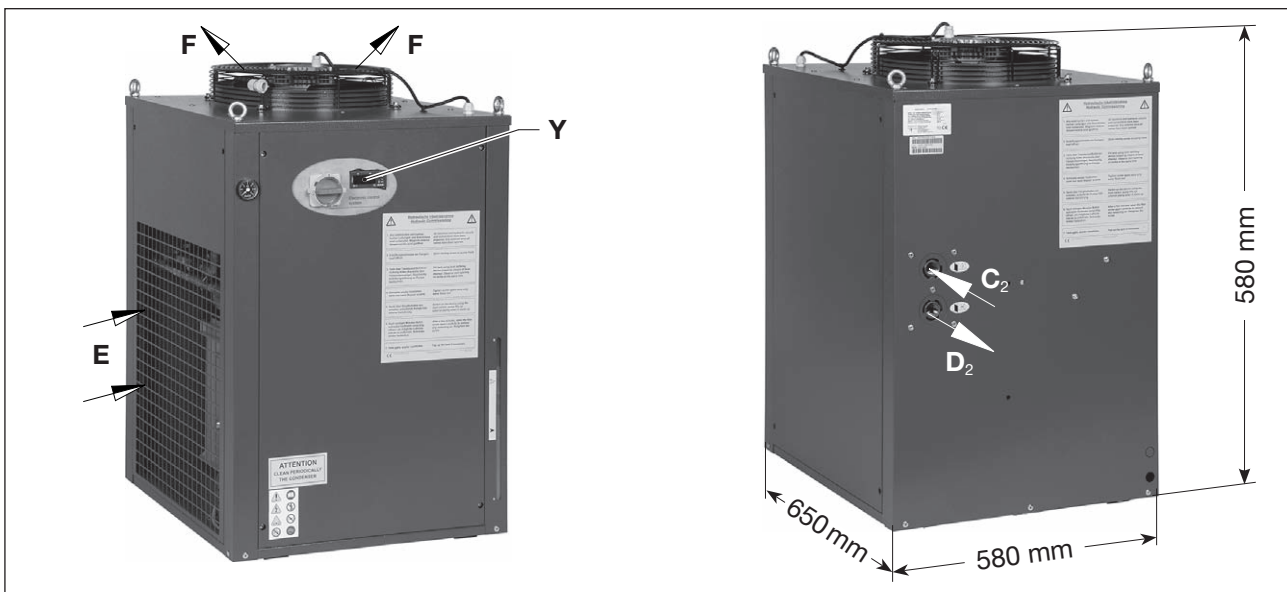

Fig. 8 Circulation cooling system (option)

- C₂** Cooling water inlet G^{3/4}
- D₂** Cooling water outlet G^{3/4}
- E** Cooling air inlet
- F** Cooling air outlet
- Y** Display

The cooling circuit is fitted with thermostat-controlled three-way valves. This enables diversion of water past the heat exchanger during the pump start-up phase. During operation of the pump, a temperature switch monitors the water temperature and a flow switch controls the flow rate.

- 📄 Further detailed technical data on request
- 📄 The Operating Instructions for this cooling system is enclosed on the device.

Weight / operating weight	101 / 131 kg
Tank capacity	30 l

5 Installation

NOTICE

The installation and initial operation may only be made by authorised skilled personnel, which is trained over corresponding safety regulations in handling oxygen installations.

The rule of the government safety organisation BGR 500, chapter 2.32 (operating of oxygen installations) or other relevant national standards must be followed.

5.1 Preparing for installation

Check the following points:

- Machine freely accessible from all sides
- Do not close ventilation grids and holes
- Sufficient room for installing and removing pipes and for maintenance work, particularly for installing and dismantling the machine
- No external vibration effects
- Do not suck any hot exhaust air from other machines into the cooling system.



The oil filling point (Fig. 2/H, H₁), oil sight glass (Fig. 2/I, I₁) and oil outlets (Fig. 2/K, K₁), cooling water inlet (Fig. 3/C) and cooling water outlet (Fig. 3/D) must be easily accessible. The cooling air inlets (Fig. 3/E) and cooling air outlets (Fig. 3/F) must be at least 30 cm away from adjacent walls. Cooling air coming out must not be sucked in again.



DANGER

The screw vacuum pump VSI OXY is not gas-tight

It may lead to danger of explosion!
No incorrect oxygen concentration may occur in the vicinity of the vacuum pump. Therefore the installation area must be always aerated sufficiently.

5.2 Installation

NOTICE

The machine may only be operated when it is set up horizontally.

Material damage resulting from the machine tipping over and falling.

When installed at more than 1000 m above sea level a reduction in power is noticeable. In this case we would ask you to contact us.

Contamination in the intake air

To protect the machine the operator should install appropriate filters on the suction side.

Check for oil leakage

Risk of falling in oil spills!

Ensure that the foundation complies with the following conditions:

- Level and straight
- The bearing surface must be designed to be able to take the weight of the machine.



It is possible to install the machine on a firm base without anchoring. When installing on a sub-structure we recommend fixing with flexible buffers.



DANGER

Pollution in the suction medium

Suction of pollution in particular organic substances may cause acute danger of explosion!

To protect the VSI OXY the operator should install an appropriate filter on the suction side or the vacuum tight suction filter (ZVF) must be installed.

5.3 Connecting pipes

- a) Vacuum connection at (Fig. 2/A, 3/A).

NOTICE

Material damage resulting from the forces and torques of the pipes on the unit being too high.
Only screw pipes in by hand.

The pumping capacity of the vacuum pump is reduced if the suction pipe is too narrow and/or too long.

- b) The discharged air can be blown out through the exhaust silencer at (Fig. 3/B) or conducted away using a hose or a pipe.

NOTICE

The air vent (Fig. 3/B) must not be closed or restricted.

Counter pressures on the outlet side are only permissible up to:

S-VSI (43) 7.5 kW < +0.2 bar

S-VSI (43) 5.5 kW < +30 mbar

Prevent liquids accumulating in the exhaust line.

5.4 Connecting the cooling water pipe

NOTICE

Cooling water control!

The vacuum pump must not be operated without cooling water control.

Danger breakdown of the pump

Ensure that the cooling water stream is not interrupted.

- a) Connect the cooling water pipe to the cooling water inlet (Fig. 3/C) and the cooling water discharge pipe to the cooling water outlet (Fig. 3/D).

NOTICE

Only use pH-neutral, clean and filtered water for cooling

Dirt particles and aggressive water may lead to malfunctions or to premature wear in the cooling system



Suitable cooling water

see Info "Recommended water quality", Page 4

NOTICE

The cooling water operating pressure must not exceed 6 bar

Cooling water temperature must be between 15 - 50°C.

- b) When connecting a circulating cooling system to an external cooling system, it must be filled with cooling fluid.

NOTICE

Rinse the pipe network on the customer side before connecting it

A filter element must be installed in the pipe network to prevent foreign bodies getting into the heat exchanger.

Risk of frost damage in the cooling system

Freezing cooling water may lead to extensive damage to the machine. Therefore mix the cooling water with at least 10 % of anti-freeze. The amount of anti-freeze used must be adjusted to the ambient climatic conditions.

Handling anti-freeze

Anti-freeze may contain harmful ingredients, such as ethylene glycol that could damage your health, especially if swallowed.

5.5 Filling with lubricating oil



Specified lubrication oil:

OXY-GEAR-LUBE 160

- a) Fill the lubricating oil for the gear teeth and the bearings into the oil filling points (Fig. 2/H, 2/H₁) up to the middle of the inspection glasses (Fig. 2/I, 2/I₁).
- b) Close the oil filling points.

5.6 Connecting the motor

**DANGER****Danger of death if the electrical installation has not been done professionally!**

The electrical installation may only be done by a specialist electrician observing EN 60204. The operating company has to provide the main switch.

- a) The motor's electrical data is given on the data plate (Fig. 3/N) or on the motor data plate (Fig. 2/P₁). The motors comply with DIN EN 60034 and are in protection class IP 55 and insulation class F. The appropriate connection diagram is located in the motor's terminal box (not for the plug connection version). The motor data must be compared with the data of the existing mains network (current type, voltage, network frequency, permitted current value).
- b) Connect the motor via a motor protection switch (a connecting cable must be installed via a cable fitting to provide strain relief).
We recommend using motor protection switches with delayed switch off, depending on possible excess current. Temporary excess current may occur when the machine is started cold.

NOTICE**Power supply**

The conditions at the installation location must match the information on the motor data plate.

Without derating the following is permissible:

- $\pm 5\%$ Voltage deviation
- $\pm 2\%$ Frequency deviation

6 Commissioning and decommissioning

6.1 Commissioning

WARNING

Improper use

May lead to severe or fatal injuries. Therefore be sure to obey the safety instructions.



CAUTION

Hot surfaces

When the machine is at operating temperature the surface temperatures on the components (Fig. 2/ Q) may go above 70°C.

You must avoid touching the hot surfaces (marked with warning plates)!



CAUTION

Noise emission

The highest noise pressure levels measured as per EN ISO 3744 are given in Section 9.

When spending a long time in the vicinity of the running machine use ear protectors to avoid permanent damage to your hearing.

CAUTION

Do not put your hands onto the suction connection to check the suction

NOTICE

Do not operate without water cooling with a sufficient amount of cooling water

The power of the machine lessens and damage may occur to the machine.



DANGER

Specified lubrication oil

Any non compliance may lead to acute danger of explosion!

For lubrication of the vacuum pumps VSI OXY may be only used the oil type **OXY-GEAR-LUBE 160** specified by Elmo Rietschle.

Mixing of organic substances with oxygen can cause explosive mixtures

Any non compliance may lead to acute danger of explosion!

Assuming that the lubricant could be mixed with organic substances, the oil must be immediately changed.

In the case of an impurity of the vacuum pump with organic substances, the pump must be put out of action and be cleaned by authorised skilled personnel of Elmo Rietschle.

6.1.1 Checking the rotation direction

- ▷ The drive shaft direction of rotation is shown by the rotation direction arrow (Fig. 2/O) on the motor flange.
- a) Start the motor briefly (max. two seconds) to check the direction of rotation. When looking at the motor fan, it must rotate clockwise.

NOTICE

Incorrect direction of rotation

Operating in the wrong direction of rotation leads to damage to the machine.

Use a phase sequence indicator to check the direction of rotation (**anti-clockwise rotating field**).

6.1.2 Post-run

For removing accrued dampness and impurities out of the pump before non-operating of >2 hours, let the vacuum pump post-run at 50 - 100 mbar (abs.) with dry air minimum 10 minutes.

CAUTION

Condensate formation and impurities

By heightened condensate formation and impurities after shutdown of the machine deposits can adhere to rotors as well as compressor housing and prevent an starting when restart.



According to application we recommend, let the vacuum pump post-run with purge gas. Please contact the manufacturer should the pump be used under such conditions.

6.2 Decommissioning/ storing

Stop the machine

- a) Switch the machine off.
 - b) If available close the cut off device in the suction and pressure pipe.
 - c) Disconnect the machine from the electricity source.
 - d) Depressurise the machine: Open the pipes slowly
⇒ The pressure reduces slowly.
 - e) Remove the pipes and hoses.
 - f) Seal the connections for suction and discharge nozzles with adhesive foil.
 - g) Discharge cooling water (Fig. 3/D₁).
 - h) Discharge condensate (Fig. 2/X).
- 📄 see also Section 3.2.1, Page 11

6.3 Re-commissioning

- a) Check the condition of the machine (cleanliness, cabling etc.).
📄 For installation see Section 5 Page 18
📄 For commissioning see Section 6.1 Page 24

7 Maintenance and repair

NOTICE

The maintenance and servicing may only be made by authorised skilled personnel, which is trained over corresponding safety regulations in handling oxygen installations.



DANGER

Danger of death from touching live parts!
Before maintenance work disconnect the machine by pressing the main switch or unplugging it and ensure that it cannot be turned on again.



WARNING

Hot surfaces and equipment
During maintenance work there is the danger of getting burnt on hot components (Fig. 2/Q) and by the machine lubricating oil.
Wait for the machine to cool down.

DANGER

Do not use oleaginous compressed air
Any non compliance may lead to acute danger of explosion!
Do not use compressed air for any maintenance work because it is not guaranteed that the compressed air is oil free.

7.1 Ensuring operational safety

Regular maintenance work must be carried out in order to ensure operational safety.

Maintenance intervals also depend on the operational demands on the machine.

With any work observe the safety instructions described in Section 2.8 “Safety notes for installation, commissioning and maintenance”.

The whole unit should always be kept in a clean condition.

7.2 Maintenance work

Interval	Maintenance to be carried out	Section
monthly	Check the pipes and screws for leaks and to ensure they are seated properly and if necessary seal again or tighten up.	—
monthly	Check the terminal box and cable inlet holes for leaks and if necessary re-seal.	—
monthly	Clean cooling ribs of the machine and the motor.	—
depending on condensate formation	Discharge condensate (Fig. 2/X)	
monthly	Check the oil level	7.2.1
7.500 h	Changing the oil	
depending on how dirty the discharged medium is	Clean intake air filter Clean gas ballast valve filter	7.2.2
at least once a year	Check for coupling wear	7.2.3
monthly	Check the cooling water system and the pipes.	7.2.4
depending on how dirty the cooling liquid is	Clean dirt trap	

7.2.1 Changing the oil

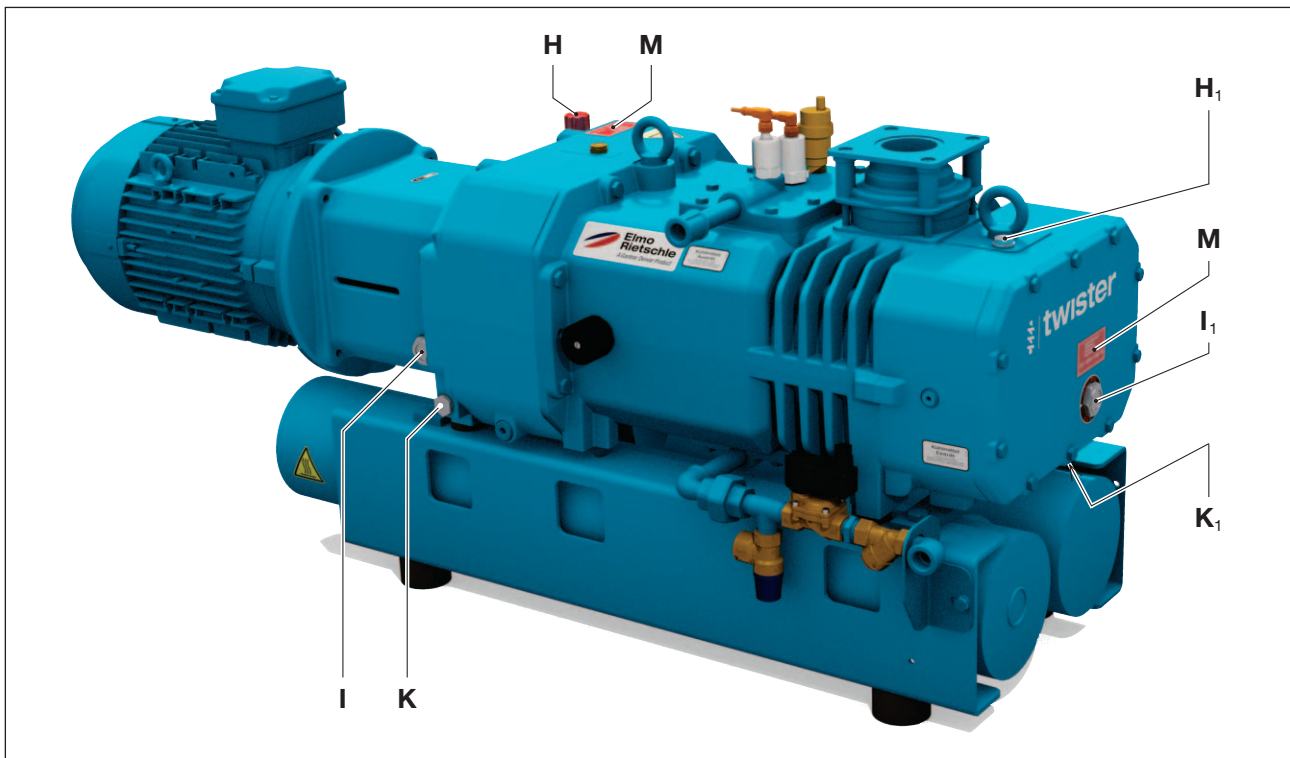

Fig. 9 Changing the oil

- H, H₁** Oil filling point
- I, I₁** Oil sight glass
- K, K₁** Oil discharge point
- M** Oil recommendation plate

NOTICE

Always change the oil when the machine is at operating temperature and in an atmospherically ventilated area. If it is not completely emptied the amount that can be refilled is reduced.

The waste oil must be disposed of in compliance with the local environmental protection regulations.

The oil level in the sight glasses (Fig. 9/I, I₁) must be checked every month. When refilling with oil the machine must be switched off and vented to atmospheric pressure. With clean operations the oil must be changed after every 7,500 operating hours.



Specified lubrication oil:
OXY-GEAR-LUBE 160

NOTICE

The vacuum pump VSI OXY may only be operated with the oil type **OXY-GEAR-LUBE 160** (see oil type plate (M)) specified by Elmo Rietschle. This lubricant is released of the Federal Institute for Materials Testing (BAM).



The lubricant **OXY-GEAR-LUBE 160** is inert and therefore it extrivates no explosive gas mixtures.



DANGER

Under no circumstances other lubricants or greases may be used (danger of explosion!).

7.2.2 Air filtering

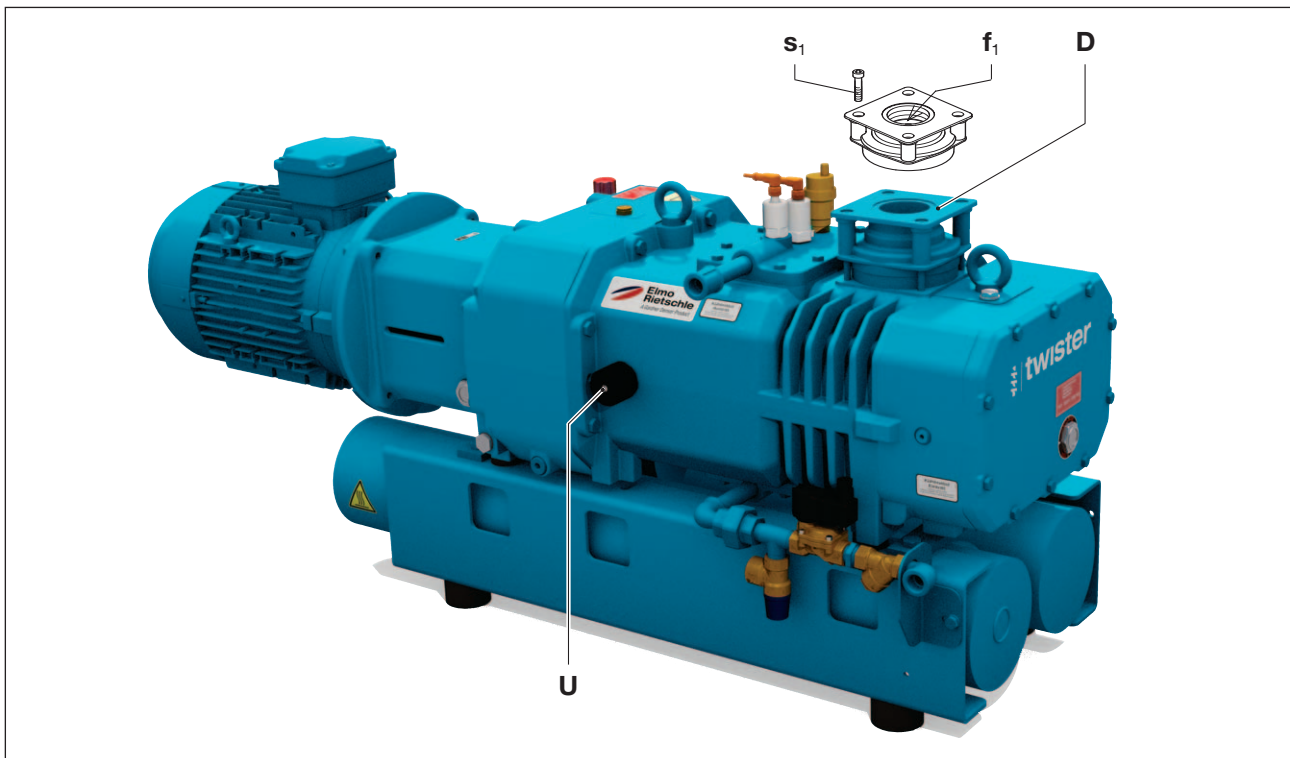

Fig. 10 Air filtering

- D Suction flange
- f₁ Mesh filter
- s₁ Screws
- U Gas ballast valve

NOTICE

Insufficient maintenance on the air filter
The power of the machine lessens and damage may occur to the machine.

Intake air filter:

The mesh filter (Fig. 10/f₁) must be cleaned by washing (depending on the level of contamination of the suctioned medium) or replaced. Remove the suction flange (Fig. 10/D) after undoing the screws (Fig. 10/s₁). Also check the valve seating for contamination. Assemble in reverse order.

NOTICE

As detergents, only the washing agent Antikor 30-57 (Kluthé) in conjunction with the wetting agent 200-4 (Kluthé) is allowed.

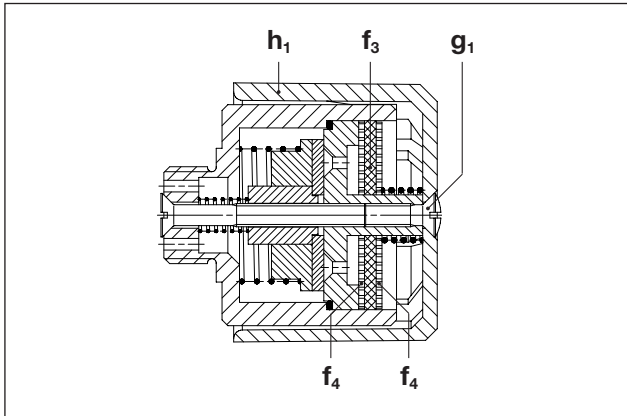

Fig. 11 Gas ballast valve

- h₁** Cover
- f₃** Filter disc
- g₁** Countersunk screw
- f₄** Micro filter discs

Gas ballast valve filter:

The pumps work with a gas ballast valve (Fig. 10/U). The inbuilt filter disc Fig. 11/f₃) and micro filter discs Fig. 11/f₄) must be cleaned more or less often by purging depending on how dirty the medium flowing through is. By undoing the countersunk screw (Fig. 11/g₁) and removing the plastic cover (Fig. 11/h₁) the filter parts can be removed for cleaning. Re-assemble in reverse order.

**DANGER**

Under no circumstances oleaginous compressed air may be used for air-cleaning of the filters (danger of explosion!).

7.2.3 Coupling

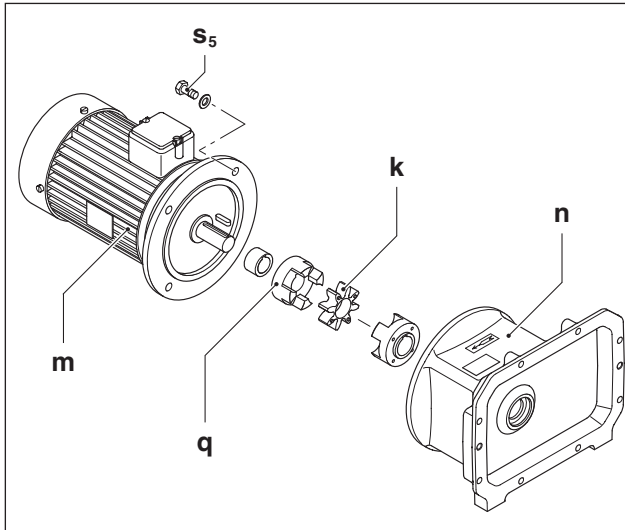

Fig. 12 Coupling

- k** Coupling sprocket
- m** Motor
- n** Motor flange housing
- q** Coupling half on the motor side
- s₅** Screws

The coupling sprocket (Fig. 12/k) is subject to wear and must be checked regularly (at least once a year).

CAUTION

Defective coupling sprocket

Defective sprockets may lead to the rotor shaft breaking.

To check the coupling switch the motor off and ensure that it cannot be switched on again. Suspend the motor (Fig. 12/m) on the eyebolt by means of lifting equipment.

Undo the screws (Fig. 12/s₅) on the motor flange. Remove motor and the coupling half on the motor side (Fig. 12/q) from the motor flange housing (Fig. 12/n) axially. If the sprocket (Fig. 13/k) is damaged or worn, then replace it.

NOTICE

Frequent starting up and high ambient temperature

The service life of the sprocket (Fig. 12/k) is reduced as a result of this.

Re-assemble in reverse order.

7.2.4 Cooling

Check the cooling water system and the pipes monthly.

Continuous flow cooling

The dirt trap (Fig. 5/U₆) must be cleaned periodically, depending on the cooling liquid quality. To do this unscrew the lock screw and clean the built-in mesh filter.

Circulation cooling

- 📄 For maintenance see Operating Instructions, is enclosed on the cooling device

7.3 Repair/ Service

- a) For on site repair work the motor must be disconnected from the mains by a qualified electrician so that it cannot be started up again accidentally. For repairs use the manufacturer, its branch offices or authorised dealers. Please contact the manufacturer for the address of the service centre responsible for you (see Manufacturer's address).

Fig. 13 Clearance certificate 7.7025.003.17

NOTICE

For each machine that is sent to an Elmo Rietschle Service centre for inspection, maintenance or repair, a fully completed, signed declaration of harmlessness must be enclosed. The declaration of harmlessness is part of the supplier's documentation.

- b) After a repair or re-commissioning, the actions listed under „Installation“ and „Commissioning“ must be carried out as for initial commissioning.

7.4 Spare parts

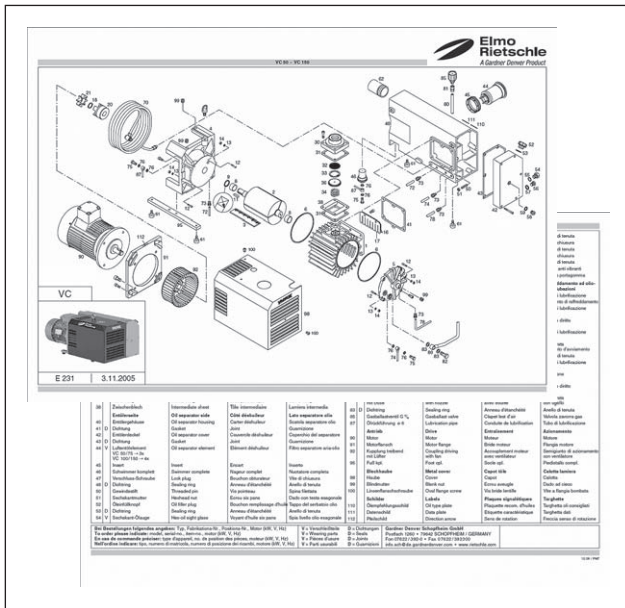

Fig. 14 Spare parts list (example)

Order spare parts in accordance with the:

- **Spare parts list:**
E 832/6 → S-VSI 300 (43) OXY
 - Download the pdf file:
<http://www.gd-elmorietschle.com>
 → Downloads
 → Product Documents
 → S-Series → Spare Parts
 - Parts subject to wear and gaskets are indicated separately on the list.
- **Web site:**
<http://www.service-er.de>
 - Select the type, size and design.

NOTICE

Only use original spare parts or parts approved by the manufacturer. The use of other parts may lead to malfunctions and invalidate liability or the guarantee for any consequences arising.



Fig. 15 Web site
<http://www.service-er.de>

8 Malfunctions: Causes and elimination

Fault	Cause	Troubleshooting	Important
Machine is switched off by the motor protection switch	Mains voltage/ Frequency does not correspond with the motor data	Check by qualified electrician	Section 5.5
	Connection to motor terminal board is not correct		
	Motor protection switch is not set correctly		
	Motor protection switch is triggered too quickly	Use a motor protection switch with an overload-dependent delayed switch off that takes into consideration the short term excess current at start up (version with short circuit and overload trigger as per VDE 0660 Part 2 or IEC 947-4)	
Pumping capacity is insufficient	The mesh filter is dirty	Clean or replace the mesh filter	Section 7.2.2 Section 7.4
	The suction pipe is too long or too narrow	Check the hose or the pipe	Section 5.3
	Machine or system leaking	Check the pipework and screw connections for leaks and to ensure that they are firmly seated	Section 7.2

Malfunions: Causes and elimination

Fault	Cause	Troubleshooting	Important
Final pressure (max. vacuum) is not reached	Machine or system leaking	Check the pipework and screw connections for leaks and to ensure that they are firmly seated	Section 7.2
	Too little cooling water	Note cooling water consumption	Section 9
	The mesh filter is dirty	Clean or replace the mesh filter	Section 7.2.2 Section 7.4
Machine gets too hot	Ambient or intake temperature is too high	Ensure it is being used properly	Section 2.3
	Cooling air supply is obstructed	Check environmental conditions	Section 5.1
		Clean the cooling ribs	Section 7.2
	The cooling water system is obstructed	Check the cooling water system and the pipes	Section 7.2
	Too little cooling water	Note cooling water consumption	Section 9
Cooling water inflow is too hot	Note the max. intake temperature	Section 9	
The machine makes a abnormal noise	Deposits on the rotors	Clean the working space and the rotors	Elmo Rietschle Service
Please contact Elmo Rietschle Service for other malfunctions or those that cannot be eliminated.			

9 Technical Data

S-VSI		300 (43) OXY	
		5.5 kW	7.5 kW
Sound pressure level (max.) 200 mbar (abs.) → 0,1 mbar (abs.) EN ISO 3744 Tolerance ±3 dB(A)	50 Hz	74	74
	60 Hz	-	76
Sound power level	50 Hz	88	
	60 Hz	90	
Weight *	kg	330	335
Length *	mm	1297	1297
Width	mm	454	454
Height	mm	580	580
Vacuum connection		G 2	
Correct amount of oil	l	1.9 (1.1 → H + 0.8 → H ₁)	
Cooling water consumption max. intake temperature: 50°C	l/min	6.7	
Cooling water pressure	bar	max. 6	

* The length and the weight may differ from the information listed here depending on the motor manufacturer.

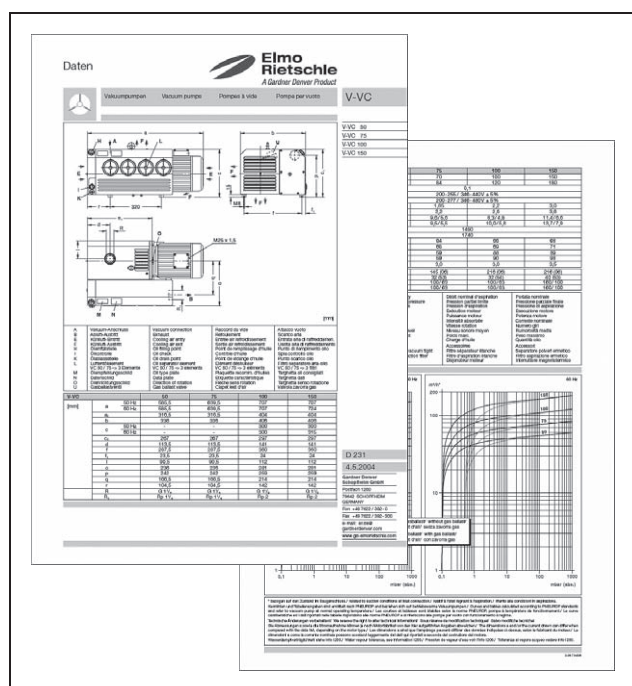

Fig. 17 Data sheet (example)

You will find more technical data on the data sheet **D 832/43**

- Download the pdf file:
D 832/43 → S-VSI 300 (43) OXY
- Download the pdf file:
<http://www.gd-elmorietschle.com>
→ Downloads
→ Product Documents
→ S-Series → Data Sheets

NOTICE

Subject to technical changes.



**Elmo
Rietschle**

Gardner

Denver

Elmo Rietschle is a brand of
Gardner Denver's Industrial Products
Division and part of Blower Operations.

EC - declaration of conformity 2006/42/EC

Hereby the manufacturer confirms: Gardner Denver Schopfheim GmbH
Postfach 1260
D-79642 Schopfheim

that the machine: vacuum pump

of the: Series: S-VSI
Type:

is conform to the regulations of the guideline indicated above.

The following harmonized and national standards and specifications are applied:

EN 1012-2:1996+A1:2009 Compressors and vacuum pumps — Safety requirements — Part 2:
Vacuum pumps

These declarations of conformity are invalid when the machine has been modified without prior approval by us and the approval has been documented in writing.

Name and address of the EC person in charge for documentation Gardner Denver Schopfheim GmbH
Postfach 1260
D-79642 Schopfheim

Gardner Denver Schopfheim GmbH
Schopfheim, 01.03.2015



Dr. Friedrich Justen, Director Engineering

Gardner Denver Schopfheim GmbH

Roggenbachstr. 58, 79650 Schopfheim Phone: +49/(0)7622/392-0 Fax: +49/(0)7622/392-300

Repairs and/or maintenance of vacuum pumps and components will only be carried out if a declaration has been filled in correctly and completely.

If not, the repair work cannot be started and delays will result.

This declaration must only be filled in and signed by authorised qualified staff.

1. Type of vacuum pumps/ components	2. Reason for the submission
Type description: _____	_____
Machine number _____	_____
Order number: _____	_____
Delivery date: _____	_____

3. Condition of vacuum pumps/ components	4. Contamination of the vacuum pumps/ components when in use
Was this being operated? YES <input type="checkbox"/> NO <input type="checkbox"/>	Toxic YES <input type="checkbox"/> NO <input type="checkbox"/>
Which lubrication was used? _____	Corrosive YES <input type="checkbox"/> NO <input type="checkbox"/>
Was the pump/ component emptied? (Product/Consumables) YES <input type="checkbox"/> NO <input type="checkbox"/>	Microbiological*) YES <input type="checkbox"/> NO <input type="checkbox"/>
Has the pump/ component been cleaned and decontaminated? YES <input type="checkbox"/>	Explosive*) YES <input type="checkbox"/> NO <input type="checkbox"/>
	Radioactive*) YES <input type="checkbox"/> NO <input type="checkbox"/>
	other YES <input type="checkbox"/> NO <input type="checkbox"/>

Cleaning agent: _____

Cleaning method: _____

*) Microbiological, explosive or radioactively contaminated vacuum pumps/ components will only be accepted with proof that they have been cleaned properly.

Type of toxic substance or process-related, dangerous reaction products with which the vacuum pumps/ components came into contact:

Trade name, manufacturer's product name	Chemical name	Hazard class	Action to be taken if toxic substances are released	First aid in the event of accidents
1				
2				
3				
4				

Personal protection measures: _____

Hazardous decomposition products when subjected to thermal load YES NO

Which? _____

5. Legally binding declaration

We swear that the information in this declaration is accurate and complete and that I, the undersigned, am in a position to judge this. We are aware that we are liable to the contractor for damage caused by incomplete and inaccurate information. We undertake to release the contractor from any damage claims from third parties arising from incomplete or incorrect information. We are aware that, regardless of this declaration, we are directly liable to third parties including in particular the contractor's staff entrusted with handling or repairing the product.

Company: _____

Street: _____ Post code/ Town: _____

Phone: _____ Fax: _____

Name (in capitals) _____ Position: _____

Date: _____ Company stamp: _____

Legally binding signature: _____